

PowerWAVE 6000

(60–500 kVA)

Technical Specification



PowerWAVE 6000 DESCRIPTION

Continuous power availability is essential in today's dynamic IT and process-related environments. It is equally important that any installed power protection system is sufficiently resilient and adaptable to handle any changes brought about by the introduction of new server technologies, migration and centralization. Such demands are well met by the PowerWAVE 6000 UPS system, which provides the foundation for continuous power availability of network-critical infrastructures both in enterprise data centres, where business continuity has paramount importance, and in process control environments where manufacturing continuity is essential.

The PowerWAVE 6000 UPS, which is available over a model range of 60kVA to 500kVA, incorporates the latest technological developments in power engineering and represents a completely new generation of high power, three phase UPS systems. Its advanced double conversion VFI (Voltage and Frequency Independent) topology responds fully to both the highest availability and environmentally friendly requirements compliant with IEC 62040-3 (VFI-SS-111) standards.

PowerWAVE 6000 features innovations that combine to deliver the industry's best key values such as: enhanced power performance, parallel capability and connectivity's interaction.

Uninterruptible Power Supplies Ltd. specialises in the installation and maintenance of Uninterruptible Power Systems; and this powerful UPS is just one example of our wide range of state-of-the-art power protection devices that will provide your critical equipment with a steady and reliable power supply for many years.

PowerWAVE 6000 configurations

The PowerWAVE 6000 UPS can be configured to operate as a single, stand-alone UPS or several (up to 10) UPS cabinets can be connected in parallel to operate as a multi-module UPS system. A multi-module configuration is generally chosen either to increase a system's total power capacity or to provide module redundancy in order to keep the load supplied in the event of a module failure.

Due to its Decentralised Parallel Architecture (DPA) design, each PowerWAVE 6000 UPS can take the leadership role when operating in a multi-module system. This avoids a single point of failure in the parallel chain and ensures the highest level of power availability.

System expansion

Most data centres present a low initial power demand which increases as the data centre grows to its full capacity; and it is essential that the installed power protection system can be expanded to meet a growing demand without compromising the existing load. This situation is easily managed in a PowerWAVE 6000 multi-module installation by adding an additional UPS(s) to an existing system to increase the overall system capacity without having to temporarily transfer the load to the raw mains supply. This results in the highest level of power availability interruption free.

Key features

The highlights of this innovative UPS solution include its high reliability, upgrade ability, low operating costs and excellent electrical performance.

KEY FEATURES	
Compact size, small foot print	Space saving on expensive floor space
Flexible battery management	Advanced management of battery charging and preventive failure diagnostics avoids premature deterioration of battery life.
Best in class ac-ac efficiency, up to 96%	Energy-Operational cost savings (TCO)
Low input power factor (near unity)	Cost savings during installation and the entire life cycle (TCO)
Blade-server-friendly power; full power from 0.9 lead to 0.9 lag	No de-rating required with leading PF loads
Very low input current distortion THDi THDi = < 3.5% @ 100% load	Gen-set power and installation cost saving

GENERAL SPECIFICATIONS

This Technical Specification provides detailed technical information on the mechanical, electrical and environmental performance of the PowerWAVE 6000 60-500kVA model range, and is intended to support and provide answers to tender and end-user requirements.

MECHANICAL CHARACTERISTICS 60-100kVA (No Battery Enc.)				
Rating (kVA)		60	80	100
Dimensions (WxHxD)	mm	550 x 1820 x 750		
Dimensions with elevation kit (WxHxD)	mm	550 x 1975 x 750		
Weight	kg	205	225	230
Colour		Graphite Grey (RAL 7024)		
Batteries		Fitted in external enclosure		
Input and output power cable entry		Bottom		
Exhaust cooling air		Rear		



MECHANICAL CHARACTERISTICS 60-100kVA (Battery Enc. A)				
Rating (kVA)		60	80	100
Dimensions (WxHxD)	mm	970 x 1820 x 750		
Dimensions with elevation kit (WxHxD)	mm	970 x 1975 x 750		
Weight without batteries fitted	kg	250	260	285
Weight with 80 x 28Ah batteries fitted	kg	1140	1150	1175
Colour		Graphite Grey (RAL 7024)		
Batteries (Max configuration)		80 x 28Ah Battery blocks mounted on 16 shelves.		
Input and output power cable entry		Bottom		
Exhaust cooling air		Rear		



MECHANICAL CHARACTERISTICS 60-100kVA (Battery Enc. B)				
Rating (kVA)		60	80	100
Dimensions (WxHxD)	mm	1180 x 1820 x 750		
Dimensions with elevation kit (WxHxD)	mm	1180 x 1975 x 750		
Weight without batteries fitted	kg	260	270	295
Weight with 120 x 28Ah batteries fitted	kg	1590	1600	1625
Colour		Graphite Grey (RAL 7024)		
Batteries (Max configuration)		120 x 28Ah Battery blocks mounted on 24 shelves.		
Input and output power cable entry		Bottom		
Exhaust cooling air		Rear		



MECHANICAL CHARACTERISTICS 120-200kVA				
Rating (kVA)		120	160	200
Dimensions (WxHxD)	mm	850 x 1820 x 750		
Dimensions with elevation kit (WxHxD)	mm	850 x 1975 x 750		
Weight	kg	280	290	310
Colour		Graphite Grey (RAL 7024)		
Batteries		Fitted in external enclosure		
Input and output power cable entry		Bottom		
Exhaust cooling air		Rear		



MECHANICAL CHARACTERISTICS 250-300kVA			
Rating (kVA)		250	300
Dimensions (WxHxD)	mm	1100 x 1920 x 750	
Dimensions with elevation kit (WxHxD)	mm	1100 x 1975 x 750	
Weight	kg	390	410
Colour		Graphite Grey (RAL 7024)	
Batteries		Fitted in external enclosure	
Input and output power cable entry		Bottom	
Exhaust cooling air		Rear	



MECHANICAL CHARACTERISTICS 400-500kVA			
Rating (kVA)		400	500
Dimensions (WxHxD)	mm	1650 x 1994 x 850	
Dimensions with elevation kit (WxHxD)	mm	1650 x 2094 x 850	
Weight	kg	950	1000
Colour		Graphite Grey (RAL 7024)	
Batteries		Fitted in external enclosure	
Input and output power cable entry		Bottom	
Exhaust cooling air		Top	



MECHANICAL CHARACTERISTICS 400-500kVA + Top Cable Entry (TCE) cabinet			
		Rating (kVA)	
		400	500
Dimensions (WxHxD)	mm	2150 x 1994 x 850	
Dimensions with elevation kit (WxHxD)	mm	2150 x 2094 x 850	
Weight with TCE basic	kg	950+115	1000+115
Weight with TCE single input feed + cables	kg	950+245	1000+245
Weight with TCE dual input feed + cables	kg	950+285	1000+285
Colour	Graphite Grey (RAL 7024)		
Batteries	Fitted in external enclosure		
Input power cable entry	Top		
Output power cable entry	Bottom		
Exhaust cooling air	None		



SYSTEM CHARACTERISTICS					
Topology		On-line, double conversion, Voltage and Frequency Independent (VFI)			
Technology		Second generation transformerless design			
Parallel configuration expansion		For added redundancy and/or capacity a parallel system can be extended to up to 10 modules on request			
Double conversion AC/AC efficiency with fully charged battery and linear load (PF = 1)	Load	25%	50%	75%	100%
	% eff.	95.5%	96.0%	95.5%	95.0%

INPUT CHARACTERISTICS											
		60	80	100	120	160	200	250	300	400	500
Nominal input voltage	V	3x 380/220V+N, 3x 400/230V+N, 3x 415/240V+N									
Input voltage tolerance (ref to 3x400/230V) for Loads in %:	V	(-23% to +15%) 3x308/177 V to 3x460/264 V for <100 % load (-30% to +15%) 3x280/161 V to 3x460/264 V for < 80 % load (-40% to +15%) 3x240/138 V to 3x460/264 V for < 60 % load									
Input frequency	Hz	35-70									
Inrush current	A	Limited by soft start									
Max. Input Power with rated output power and charged battery (pf=1.0)	kW	64	85	107	128	170	213	266	319	426	532
Max. Input Current with rated output power and charged battery (pf=1.0)	A	93	123	154	185	247	308	386	463	617	771
Max. Input Power with rated output power and discharged battery (pf=1.0)	kW	70	94	117	141	187	234	293	351	468	585
Max. Input Current with rated output power and discharged battery (pf=1.0)	A	102	136	170	204	271	339	424	509	679	848
	Load	25%	50%	75%	100%						
Input power factor (leading)		0.96	0.985	0.99	0.99						
Input current distortion (THDi) (%)		9.0	6.0	4.5	3.5						

BATTERY CHARACTERISTICS		60	80	100	120	160	200	250	300	400	500	
Variable number of 12V battery blocks (only even numbers allowed)	No.	44/50					50	44/50				
Max. battery charger current	A	25			50			60		100		
Battery type		Maintenance-free VRLA or NiCd										
Temperature controlled charger		Yes (temperature sensor optional)										
Battery charging curve		Ripple-free: IU (DIN 41773)										
Battery test		Automatic and periodic (adjustable)										

OUTPUT CHARACTERISTICS		60	80	100	120	160	200	250	300	400	500
Output rated power (@min 44 battery blocks)	kW	60	80	100	120	160	*200	250	300	400	500
Output current In (PF=1.0) (@min 44 battery blocks)	A	87	116	145	174	232	*290	361	433	577	722
Output rated voltage	V	3x 380/220 or 3x 400/230 or 3x 415/250									
Output voltage stability (Static)	%	< ± 1.0									
Output voltage stability (Dynamic)	%	< ±4 (with load step 0-100%, 100-0%)									
Output voltage distortion with linear load	%	< 2 with linear load									
Output voltage distortion with non-linear load	%	< 4 (EN 62040-3:2001)									
Output frequency	Hz	50 or 60									
Output frequency tolerance	%	±0.1 free-running, quartz oscillator ±2 or ±4 with mains synchronised (selectable)									
Frequency slew rate	Hz/s	1.0									
Output waveform		Sinewave with 0deg. phase imbalance @100% unbalanced load									
Permissible unbalanced load	%	100% (all 3 phases independently regulated)									
Overload capability on inverter	%	At PF=1.0 110% load for 10 minutes At PF=1.0 135% load for 1 minute At PF=0.9 125% load for 10 minutes At PF=0.9 150% load for 1 minute									
Inverter short circuit capability (x rated output for 40ms)	A	2.7x	2.0x	2.3x	1.8x	1.9x	2.1x	1.8x	2.0x	2.0x	2.0x
Bypass short circuit capability		10x rated In for 10ms									
Crest factor		3:1									
Bypass operation		At ±15.0% of nominal input voltage									
* With 50 battery blocks only											

OUTPUT POWER VERSUS COS Ø															
Module		Inductive (lagging COS Ø)								Unity	Capacitive (leading COS Ø)				
		0.6	0.65	0.7	0.75	0.8	0.85	0.9	0.95		1.0	0.95	0.9	0.85	0.8
60	kVA	60	60	60	60	60	60	60	60	60	60	60	60	59	58
	KW	36	39	42	45	48	51	54	57	60	57	54	50	46	
80	kVA	80	80	80	80	80	80	80	80	80	80	80	80	78	77
	KW	48	52	56	60	64	68	72	76	80	76	72	66	61	
100	kVA	100	100	100	100	100	100	100	100	100	100	100	100	98	97
	KW	60	65	70	75	80	85	90	95	100	95	90	83	77	
120	kVA	120	120	120	120	120	120	120	120	120	120	120	120	117	116
	KW	72	78	84	90	96	102	108	114	120	114	108	100	92	
160	kVA	160	160	160	160	160	160	160	160	160	160	160	160	156	154
	KW	96	104	112	120	128	136	144	152	160	152	144	132	122	
200*	kVA	200	200	200	200	200	200	200	200	200	200	200	200	195	194
	KW	120	130	140	150	160	170	180	190	200	190	180	166	154	
250	kVA	250	250	250	250	250	250	250	250	250	250	250	250	245	241
	KW	150	163	175	188	200	213	225	238	250	238	225	208	192	
300	kVA	300	300	300	300	300	300	300	300	300	300	300	300	294	291
	KW	180	195	210	225	240	255	270	285	300	385	270	249	231	
400	kVA	400	400	400	400	400	400	400	400	400	400	400	400	392	388
	KW	240	260	280	300	320	340	360	380	400	380	360	333	310	
500	kVA	500	500	500	500	500	500	500	500	500	500	500	500	490	485
	KW	300	325	350	375	400	425	450	475	500	475	450	417	338	

*Vout=230Vac (L-N), 50 Hz, with minimum of 44 battery blocks (*50 Battery blocks on 200kVA model)*

STANDARDS	
Safety	EN62040-1-1:2003 EN60950-1:2001/A11;2004
Electromagnetic compatibility	IEC/EN 62040-2:2005, IEC/EN61000-3-2:2000, IEC/EN61000-6-2:2001,
Performance	EN 62040-3:2001
Product certification	CE
Degree of protections	IP20

ENVIRONMENTAL CHARACTERISTICS											
		60	80	100	120	160	200	250	300	400	500
Audible noise @ 100/50% load	dBA	< 65			< 69			< 71		N/A	
Ambient temperature for UPS	°C	0-40									
Ambient temperature for batteries (recommended)	°C	20									
Battery storage time at ambient temperature		Maximum 6 months									
Fan assisted cooling air flow		Front entry, rear exit								Front entry top exit	
Airflow (25 - 30°C) with 100% non-linear load	m³/h	1300	1500	1700	2500			3350		6550	
Heat dissipation with 100% non-linear load	W	3830	5106	6368	7660	10213	12766	15957	19149	24000	30000
Heat dissipation with 100% non-linear load	BTU/h	13071	17428	21785	26142	34856	43570	54462	65355	81913	102389
Heat dissipation without load	W	850			1500			2300		4000	
Relative air-humidity		Maximum 95% (non-condensing)									
Max altitude above sea level without derating		1000m (3300ft) without derating									
De-rating factor for use at altitudes above 1000m sea level according (IEC 62040-3)	Height above sea level (m/ft)						Derating factor for power				
		1500 / 4850					0.95				
		2000 / 6600					0.91				
		2500 / 8250					0.86				
	3000 / 9900					0.82					

COMMUNICATION OPTIONS	
Power Management Display (PMD)	LCD display and mimic diagram showing UPS operational status (Optional 7" TFT touchscreen display standard on 400/500kVA model)
Customer Interfaces: (Dry Ports)	Volt-free output interface provide status and alarm outputs for remote indication and interfacing with BMS systems. Together with customer inputs interface for connecting an Emergency Stop, On Generator status etc.
RS232 on Sub-D9 port RS232 on USB port	For monitoring and integration in network management
RS485 on RJ45 port	Remote monitoring system with graphical display (option)
RS485 on RJ45 port	For multidrop purposes (option)
Slot for SNMP Card	Ethernet card for monitoring and integration in network management (option)
Slot for SNMP Card	Modem card for GSM remote monitoring (option)

UPS CONTROL PANEL

A control panel located on the front of the cabinet provides the means for day-to-day UPS operation and performance monitoring. Two control panels are available; an LCD control panel is fitted as standard on modules up to, and including, 300kVA, and a TFT touch screen control panel is used on 400/500kVA models.

Note: The TFT control panel is available as a fitted option on the lower rated models on request.

From the UPS control panel the operator can:

- Stop and start the UPS module
- Transfer the UPS output (load) between the inverter and bypass
- Monitor the UPS input/output voltage, current and frequency
- Monitor the battery charge discharge current and battery status
- Interact with monitored alarm and warning messages
- Configure the UPS operating parameters (service mode)
- Interrogate the UPS operating events and alarm history (service mode)
- Carry out diagnostic actions (service mode)

LCD Control panel

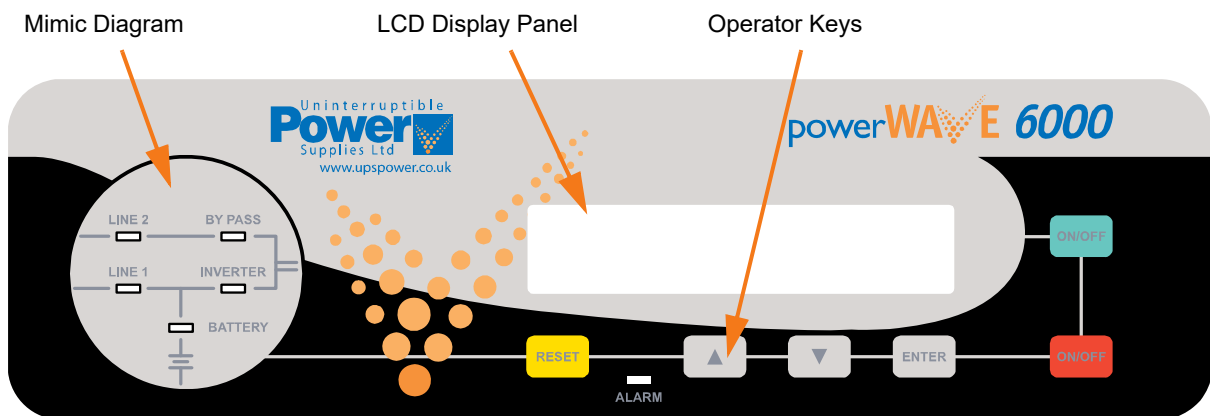

The user-friendly Power Management Display provides access to all monitoring information and operator controls.

Mimic diagram

The mimic diagram contains multi-coloured LEDs that change between GREEN, RED and OFF to indicate the UPS operation and power flow status.

LEDs LINE 1 and LINE 2 indicate the availability of the input mains and bypass mains power supplies respectively, and are both GREEN during normal operation.

The INVERTER and BYPASS LEDs indicate which of the two power sources is providing the critical load supply. These LEDs illuminate GREEN to indicate which of the two is the active supply source.

The BATTERY LED indicator is a solid GREEN when the battery is being charged and flashes when the battery is discharging – e.g. when it is providing the output load power during a mains failure.

The ALARM LED, located at the lower-centre area of the Power Management Display, is a visual indication of any monitored internal or external alarm condition. When activated, it is accompanied by an audible alarm that can be cancelled by pressing the RESET button.

LCD Display panel

The 2x 20 character multi-function LCD Display is menu-driven using the UP, DOWN and ENTER operator keys. It provides a simple communications interface that enables the operator to monitor important UPS operating parameters and alarm warnings, and carry out various control operations such as transferring the load between the inverter and bypass.

LCD Display panel summary:

- Displays the input and output voltage, current, frequency and power
- Displays an ‘Event register’ which stores a date/time stamped history of the 99 most recent alarms
- Enables battery run time monitoring
- Enables selection of commands such as UPS Start-up and Shut-down, Load transfer between inverter and bypass
- Provides diagnostic facilities and access to UPS adjustments and testing facilities (service mode only)

Operator keys

The operator keys allow the user to:

- Start and stop the UPS and transfer the load between inverter and bypass
- Set operating parameters and adjustments via the menu driven LCD display
- Select the UPS operating voltages, currents, frequencies and other values on the LCD display

There are two ON/OFF keys located on the control panel. In order to prevent inadvertent operation, both keys must be pressed simultaneously in order to turn the UPS OFF or ON.

TFT Control panel

The TFT control panel has a microprocessor-based touchscreen display which offers simple operation. When the UPS is energised the display runs through an initialisation process for several seconds and then automatically turns on, displaying the default mimic diagram screen. The screen’s backlight turns off after three minutes of inactivity and turns back on when the screen is next touched.

Default mimic display

A UPS mimic diagram is displayed on the default screen and shows the power flow through the UPS module and indicates its operating status – in either single cabinet or multi-cabinet configuration. This screen can be accessed from any other screen by pressing the MIMIC icon in the display header bar.

The functional status of each block is identified by its line colour, as shown below.

- Green – In operation
- White – Inactive
- Yellow – Warning condition
- Red – Fault conditions

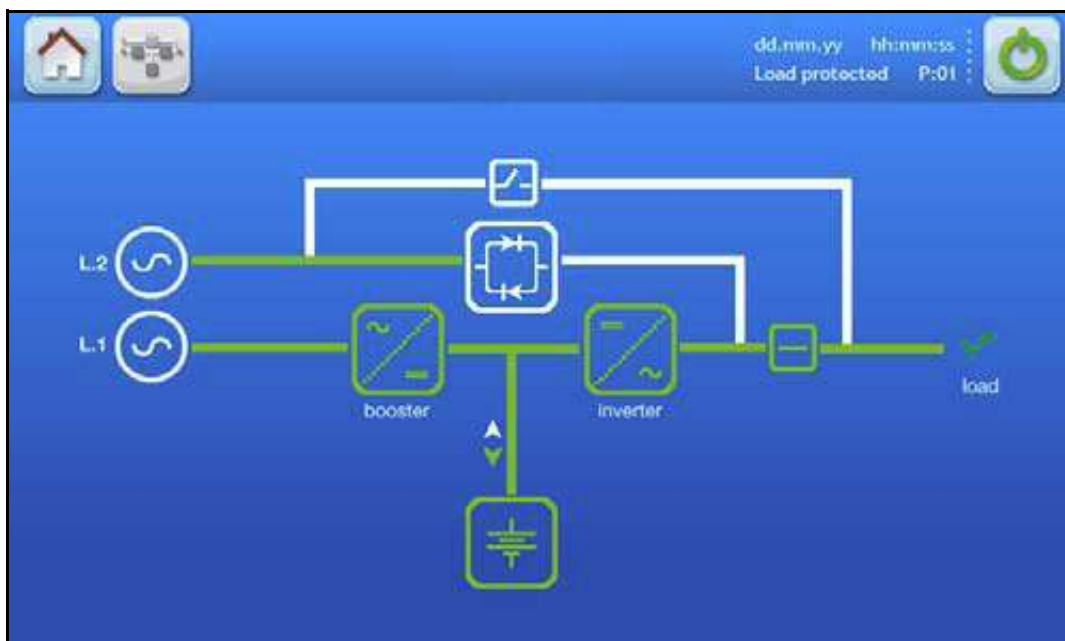

Display header bar

A navigation and status bar is displayed in the header area of every screen.



A Home	Accesses the HOME screen.
B Mimic diagram	Accesses the MIMIC diagram screen.
C Warning	The warning symbol is only visible in the presence of an alarm or monitored events. Touching this icon will silence the audible alarm and open the EVENTS screen.
D Date	Current date indication. Set in the user menu and used to date-stamp the alarms/events log.
E Time	Current time indication. Set in the user menu and used to timestamp the alarms/events log.
F ON/OFF	Turns the UPS module ON/OFF. Requires a confirmation message to be accepted.
G UPS number	Each UPS module is given a sequential number in a parallel system. The number shown here is used to identify a particular module –e g. P01 indicates the UPS number 01. In a single module installation this would indicate S01.
H Load Status	Load status: displays whether or not the load is protected, when the user is in the module navigation level.

Three meters are included on the mimic display screen to indicate the rectifier, inverter, bypass and load operating parameters. The meter source is selected by touching the associated power block on the mimic display. Displayed battery parameters include the battery temperature and remaining autonomy time.

Home screen

The home screen is accessed by pressing the HOME icon on the display header bar on any screen and contains six icons that provide access to subordinate control and set-up function screens.



A Events	Displays a list of recently occurred events with date, time, event name, description and sequential ID number. As a default the most recent appears on top.
B Measures	This item displays a full set of measurements for each functional block of the UPS (detailed below).
C Command	In this menu, the user can change the operating mode of the UPS. Once the command is executed, the user is immediately directed to the mimic diagram where the new status of the UPS is indicated (detailed below).
D UPS Data	Gives information regarding the manufacturing of the UPS.
E User	Enables the adjustment of data such as date and time, automatic battery test, etc (detailed below).
F Service	This password protect area enables the service technician to adjust several UPS parameters (detailed below).

CUSTOMER INTERFACE FACILITES

Dry ports – external wired input/output connections

All modules contain a Customer Interface Board which provides a means of connecting a number of optional, hard-wired, external input/output control and monitoring facilities. All external connections are made to Phoenix spring terminal blocks (annotated X1, X2, X3) using 0.2mm² to 1.5mm² cables. All voltage-free contacts are rated at 250Vac/8A, 30Vdc/8A, 110Vdc/0.3A, 220Vdc/0.12A.

60-300kVA Model interface connections

	Terminal	Contact	Signal	Display	Function
X1	X1/10	Gnd	Gnd		+12Vdc Power source (max 200mA)
	X1/9	In	+12Vdc		
	X1/8	Gnd	Gnd		REMOTE SHUTDOWN (Do not remove the factory-fitted bridge if this feature is not used)
	X1/7	In	+12Vdc		
	X1/6	Gnd	Gnd		Battery Temperature Sensing (If connected this input is battery temperature dependent)
	X1/5	In	+3.3V		
	X1/4	Gnd	Gnd		Customer Specific Input (1) (Function on request))
	X1/3	In	+12Vdc		
	X1/2	Out	Gnd		Customer Specific Input (2) (Default NC = Generator on line)
	X1/1	Gnd	+12Vdc		
X2	X2/15	Com	Alarm	COMMON ALARM	Common
	X2/14	NC			No Alarm Condition
	X2/13	NO			Common (System) Alarm active
	X2/12	Com	Status	LOAD ON MAINS	Common
	X2/11	NC			Load NOT On Bypass
	X2/10	NO			Load on Bypass (Mains) active
	X2/9	Com	Alarm	BATT LOW	Common
	X2/8	NC			Battery OK
	X2/7	NO			Battery Low active
	X2/6	Com	Status	LOAD ON INV	Common
	X2/5	NC			Load not On Inverter
	X2/4	NO			Load on Inverter active
	X2/3	Com	Alarm	MAINS OK	Common
	X2/2	NC			Mains Failure
	X2/1	NO			Mains Present

400-500kVA Models interface connections

	Terminal	Contact	Signal	Display	Function
X3	X3/14	Gnd	Gnd		Battery Temperature Sensing (If connected this input is battery temperature dependent)
	X3/13	In	+3.3V		
	X3/12	Gnd	Gnd	GENERATOR OPER ON	Customer Specific Input (1) (Default NC = Generator on line)
	X3/11	In	+12V		
	X3/10	Gnd	Gnd	EXTERNAL O/P BREAKER	When used, both the external output breaker and internal IA2 have to be either open or closed in order to isolate or connect the UPS. Display: PARALLEL_SW_OPEN or PARALLEL_SW_CLOSED
	X3/9	In	+12V		
	X3/8	Gnd	Gnd	EXT MAN BYP	External Manual Bypass (Default NC = External bypass closed)
	X3/7	In	+12V		
	X3/6	Out	+12V		+12Vdc Power source (max 200mA)
	X3/5	Gnd	Gnd		
	X3/4	Gnd	Gnd	REMOTE SHUT- DOWN	RSD Remote Shut Down Leave jumper JP5 in place if no Remote Shut Down input is connected
	X3/3	In	+12V		
	X3/2	-		REMOTE SHUT- DOWN	RSD Remote Shut Down (For external switch) Max 250Vac/8A, 30Vdc/8A, 110Vdc/0.3A, 220Vdc/0.12A
X3/1	-				
X2	X2/18	Com			Common
	X2/17	NC			Auxiliary NO
	X2/16	NO			Auxiliary NC
	X2/15	Com	Alarm	COMMON ALARM	Common
	X2/14	NC			No Alarm Condition
	X2/13	NO			Common (System) Alarm active
	X2/12	Com	Status	LOAD ON MAINS	Common
	X2/11	NC			Load NOT On Bypass
	X2/10	NO			Load on Bypass (Mains) active
	X2/9	Com	Alarm	BATT LOW	Common
	X2/8	NC			Battery OK
	X2/7	NO			Battery Low active
	X2/6	Com	Status	LOAD ON INV	Common
	X2/5	NC			Load not On Inverter
	X2/4	NO			Load on Inverter active
	X2/3	Com	Alarm	MAINS OK	Common
	X2/2	NC			Mains Failure
X2/1	NO	Mains Present			
X1	X1/2	230Vac	-	EXT MAN BYP	Castell Interlock Function
	X1/1	N	-		External Manual Bypass closed (230Vac 2AT)

RS232 and USB – Computer serial interface

An RS-232 serial interface is available through a standard 9-pin, female D-Type socket (JD1 Smart Port) and a standard USB port.

The Smart Port provides an intelligent RS 232 serial port which allows the UPS to be connected to a computer. When used in conjunction with the optional WAVEMON software, this enables the computer to continuously monitor the input mains voltage and UPS status, and display a message in the event of any UPS system changes.

RS485 Interface for multidrop

The computer interface (JR1) is an intelligent RS485 serial port which allows a computer to access system information from all the modules that are connected in a parallel system using the (optional) Multidrop connection kit. The retrieved data can be used to display the system operating parameters and status. JR1 is a standard RJ45 socket.

SNMP Card slots

Simple Network Management Protocol (SNMP) is a world-wide, standardised communication protocol that can be used to monitor any network-connected device via a simple control language, with the results displayed in an application running within a standard web browser.

The PowerWAVE 6000 contains two SNMP slots; one is designed to house a Modem/Ethernet SNMP adapter card and the other a Modem/GSM adapter. Alternatively, SNMP connectivity can also be implemented using an external SNMP adapter connected to the UPS RS232 output.

An SNMP/Ethernet adapter contains an RJ-45 connector which allows it to be connected to the network using a standard network cable. Once connected, the UPS-Management software agent, which is already installed in the SNMP adapter, then monitors the UPS operating parameters and outputs its data in SNMP format to the connected network. In a multi-module UPS system the SNMP interface can communicate 'system-wide' data or data for an individual UPS module.

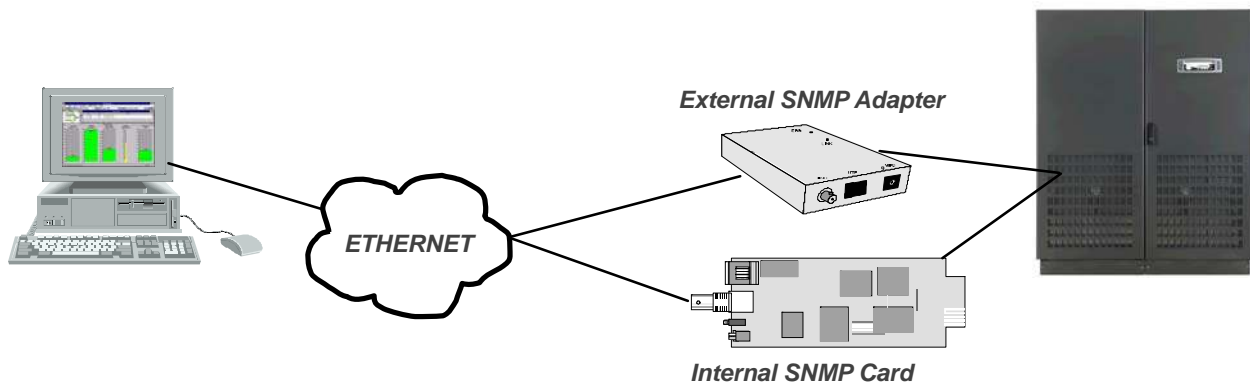

OPTIONAL UPS MONITORING AND AUTOMATED CONTROL SOFTWARE

Three (optional) monitoring systems are available for use with the PowerWAVE 6000 UPS system:

- SNMP – can be used for monitoring and controlled UPS shutdown
- WAVEMON – can be used for monitoring and controlled UPS shutdown
- PowerREPORTER – can be used to automatically email Uninterruptible Power Supplies Ltd. details of monitored parameters and alarm events for appropriate service support response

SNMP monitoring software

The SNMP adapter described above requires a PC with terminal connections and, for normal operation, at least one Ethernet network connection. It also requires that the network operating system in use is SNMP-compatible.

WAVEMON UPS monitoring and control software

WAVEMON is designed to operate in conjunction with many of the systems supplied by Uninterruptible Power Supplies Ltd. and features both UPS monitoring and automatic UPS/server shutdown facilities.

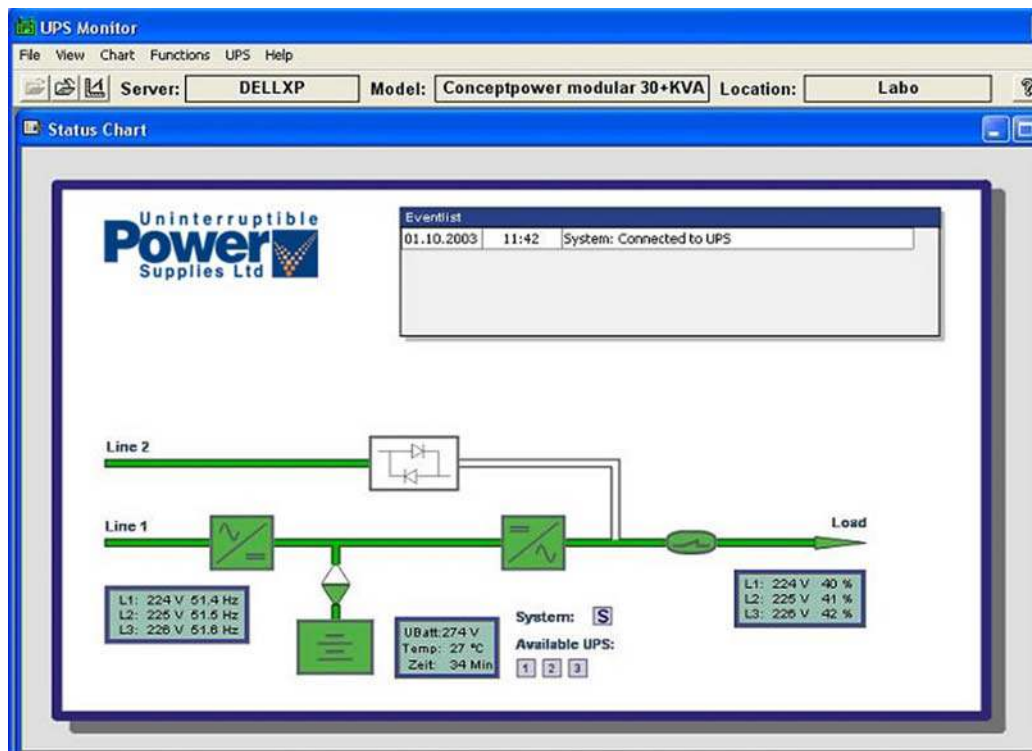

Figure 0.1 Monitoring screen image

WAVEMON comprises a bespoke software package which is installed on a local PC and communicates with the UPS via USB or a standard RS232 serial cable of up to 15m in length. It is only required when an SNMP card or adapter box is not purchased.

The main features of WAVEMON are:

- On-screen autonomy time/battery time countdown
- On-screen server log-off and shutdown procedure
- Time and date stamp event log
- Extensive logging of all UPS activity and power quality data
- Permits alarm warnings to be monitored remotely via email
- Scheduled UPS service mode and other systems status
- Graphical user interface for Windows-compatible platforms
- Automatic unattended local shutdown
- Special modules for MS-Office software to close and save open documents
- Compatible with all optional modules like UPSDIALER, SNMP adaptors, temperature sensors, etc.

Functional description

WAVEMON is a client/server software application for networks and local workstations. In general, it consists of two parts: the server module of the UPS management software is *UPSMAN*, which communicates with the UPS via an RS232/USB interface. Running as a background application, *UPSMAN* collects and interprets the messages received from the UPS and places them at the disposal of the client module *UPSMON*, as well as any connected SNMP-based instrumentation and control system.

If *UPSMAN* detects voltage variations or a power failure, it can execute various 'system event' routines, by means of which, for example, the server is switched off or a warning/alarm is sent to the connected users. These 'system event' routines are a part of the management software and can be configured in to suit local application requirements.

The software of your PowerWAVE 6000 UPS unit can be integrated into a network in two ways:

1. By the server which is supplied by the UPS itself and has been integrated into the network. In most cases this server is used as a sub-agent and you only need the WAVEMON software (without an SNMP adapter). You will also need to establish an RS232/USB connection between the UPS and computer/server.
2. In many cases the use of what is referred to as an 'SNMP adapter' is to be preferred in order to integrate the UPS into the network. In this case up to 50 computers can be shut down in one RCCMD environment. RCCMD (remote console command) is an additional software module that is used in order to execute a command (typically a shutdown command) in a remote system.

Licensing

A licence is issued with every software serial number for use of what is known as the 'UPS service' on a single server in connection with one UPS and an unlimited number of connected WINDOWS workstations. For operation with two or more servers, a further licence is required for each additional server. In this case it is of no importance whether the UPS service on these servers is active or whether the server was stopped by a remote UPS service. The same applies to the use of RCCMD with the 'remote send/receive' modules for 'multi-server shutdown' under NT, UNIX and other operating systems.

The service programs are generally supplied as single licences. In order to use a single CD-ROM for several 'multi-server shut-down' units you must acquire additional licence codes.

RCCMD Server shutdown

In order that remote shutdown of servers can take place, initiated by the SNMP card or WAVEMON software, further licenses must be purchased. The license is for the RCCMD client (or listening) software that resides in each target server.

PowerREPORTER™ management software

PowerREPORTER is a remote monitoring and management service which provides peace-of-mind protection by offering a continuous (24/7/365) watch over mission-critical facilities. Continuous monitoring is an affordable insurance policy to detect issues and provide an early warning before they develop into a crisis.

The main features and benefits offered by PowerREPORTER are:

- Real time email notification sent directly to UPSL Service Centre in response to alarm/critical events
- Acquisition of key performance data and productivity information. Empowers you with the details needed to better understand machine performance and quickly troubleshoot downtime events
- Combined with a service contract, PowerREPORTER improves service levels. The engineer can determine if site attendance is necessary and bring relevant spare parts
- Monthly Status Report detailing trends and alarms
- Optional battery analysis and care service; PowerNSURE - measures battery voltage, temperature, impedance and prolongs battery service life through the application of battery charge equalization

Functional description

PowerREPORTER communicates constantly with your UPS system in order to automatically detect any error or alarm messages. In the event of an incident being detected, PowerREPORTER automatically connects with UPS Limited Service Centre via an email, transmitting a status message.

The email, which provides details relating to the fault, a snapshot of the UPS performance parameters and a device identification string, is automatically processed and UPS Limited Service Centre personnel are alerted.

UPS Limited Service Centre personnel are then able to liaise with the company's field service team and will remotely diagnose the UPS incident before reaching the facility with appropriate spare parts within the contracted service agreement time-frame.

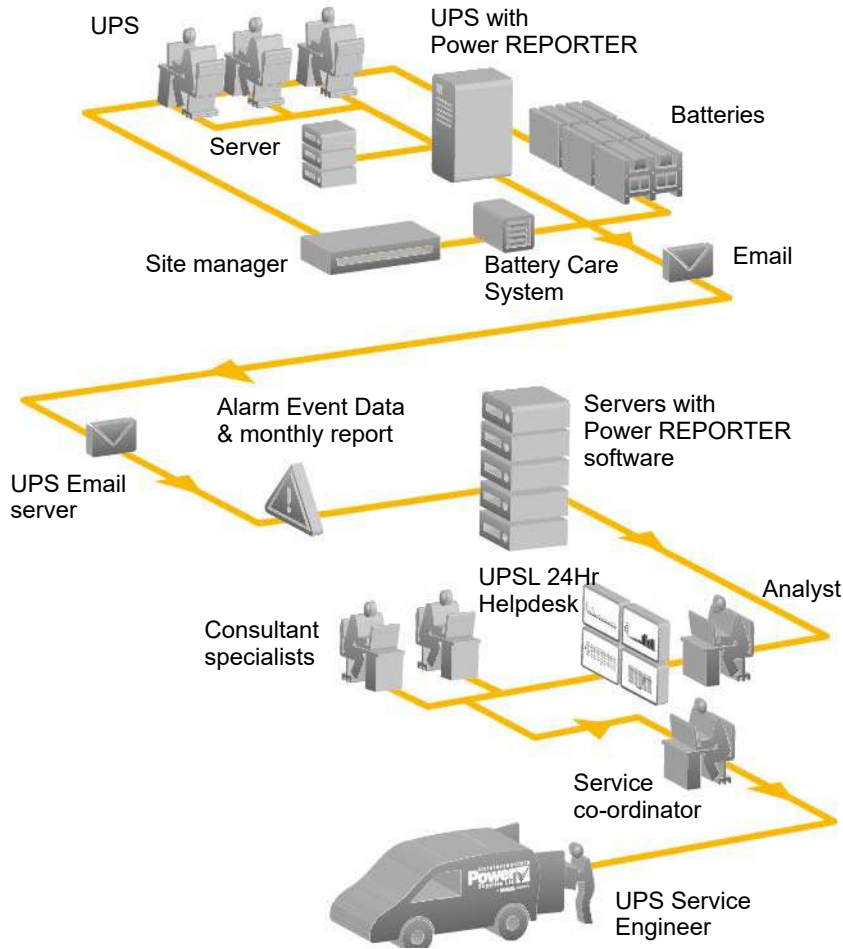

INSTALLATION PLANNING

The following *guidelines* should be taken into account when planning a suitable UPS location and environment.

Location considerations summary

- The equipment must be installed and transported in a upright position
- The floor at the installed location and en-route from the off-loading point must be able to safely take the weight of the UPS and battery equipment
- The floor material where the UPS is to be located should be non-flammable
- Local fire protection standards must be respected
- Ensure that appropriate power supplies are available and that UPS cabling can be performed easily
- The location must be vibration free
- If the UPS is to be installed in bayed enclosures, partition walls must be installed.

Environmental considerations summary

- Avoid high ambient temperature, moisture and humidity
 Humidity (< 90% non-condensing) and temperature (+15°C / +25°C) are within prescribed limits
- An ambient temperature of 20°C is recommended to achieve a long battery life
- Any prescribed air cooling flow must be available. Ensure the air conditioning system can provide a sufficient amount of air cooling to keep the room at, or below, the maximum desired temperature
- Ensure no dust or corrosive/explosive gases are present

MAXIMUM HEAT DISSIPATION (with non-linear load)		60	80	100	120	160	200	250	300	400	500
Airflow		From front to back									From front to top
Heat dissipation with 100% non-linear load (EN 62040-1-1)	W	3830	5106	6383	7660	10213	12766	15957	19149	24000	30000
Heat dissipation with 100% non-linear load (EN 62040-1-1)	BTU/h	13071	17428	21785	26142	34856	43570	54462	65355	81913	102389
Airflow (25° - 30°C) with 100% non-linear load (EN 62040-1-1)	m ³ /h	1300	1500	1700	2500	2500	2500	3350	3350	6550	6550
Heat Dissipation without load	W	850	850	850	1500	1500	1500	2300	2300	4000	4000

Clearances

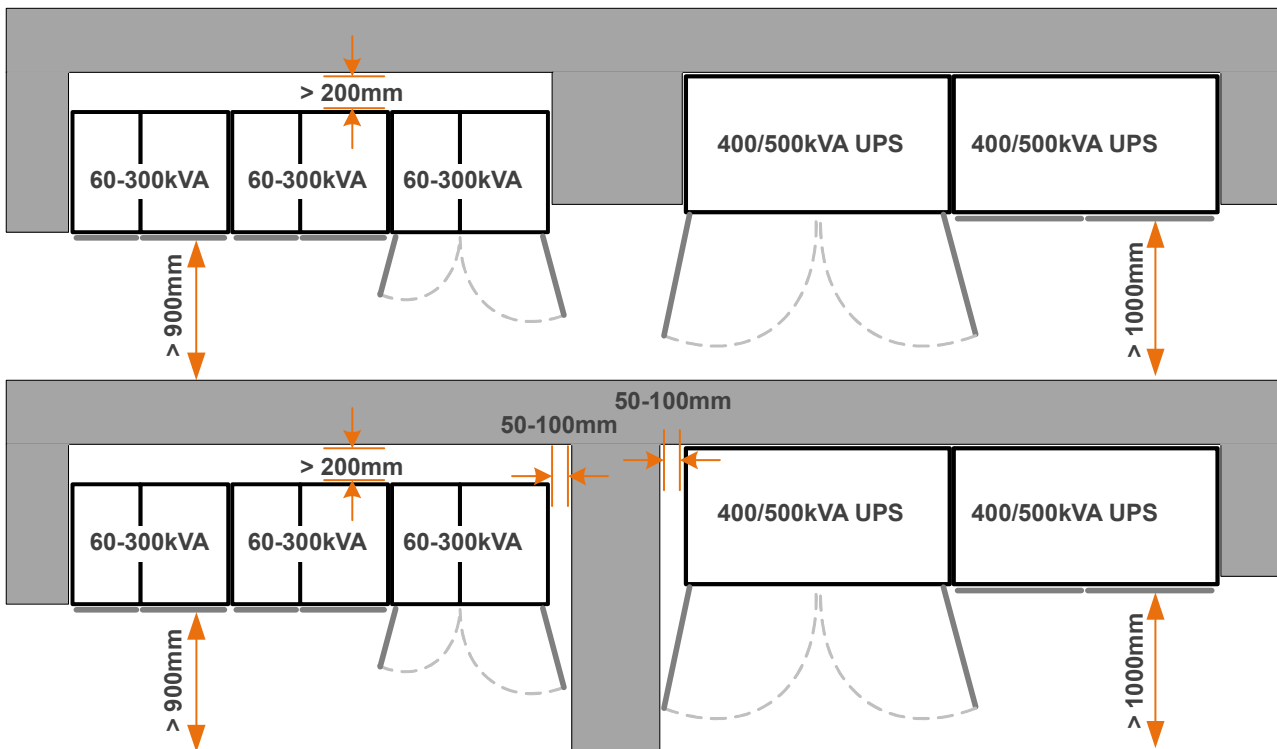

The above diagram illustrates the recommended clearances to be provided around the UPS cabinets.

Notes

1. All cables enter the UPS via the bottom of the cabinet (an optional Top Cable Entry cabinet is available for the 400/500kVA model) therefore no service/installation access is required from the rear or sides of the cabinets.
2. A minimum of 900-1000mm clearance is required at the front of the cabinets for service access, and where possible this should be increased to allow safe passage in front of the UPS with the doors open.
3. In order to gain full access to some internal components it is necessary to open the doors by slightly more than 90°. If the cabinet is located adjacent to a partition or wall that extends beyond the front of the cabinet a clearance of 50-100mm should be provided between the cabinet and the partition to allow the doors to open adequately, as illustrated in the lower diagram above. Note that there is no space required between cabinets.
4. The 60-300 kVA cabinets are force-cooled by rear-mounted extraction fans which require a minimum of 200mm space at the rear of the cabinet to allow adequate exhaust air flow.
5. The 400-500 kVA cabinets are force-cooled by roof-mounted extraction fans. These cabinets do not require any space at the rear of the cabinet but a minimum free space of 400mm is required above the cabinets.

UPS POWER CABLING

All power cables are connected to a row of busbars or terminal blocks located near the bottom of the UPS cabinet, as shown on page 20. An optional Top Entry cabinet is available for the 400/500kVA model.

Terminal Connections

	Mains Supply (3+N+PE)	Bypass Supply (3+N)	Output Load (3+N+PE)	Battery (+ / N / - / PE)	Max admissible cable section (mm ²)	Tightening Torque (Nm)
60kVA	4 x 35 mm ² + PE M8	4 x 35 mm ²	4 x 35 mm ² + PE M8	4 x M8	35	3.5
80kVA	4 x 50 mm ² + PE M8	4 x 50 mm ²	4 x 50 mm ² + PE M8	4 x M8	50	5
100kVA	4 x 70 mm ² + PE M8	4 x 70 mm ²	4 x 70 mm ² + PE M8	4 x M8	95	8
120kVA	5 x M10	4 x M10	5 x M10	4 x M10	185	Max. 50
160kVA	5 x M10	4 x M10	5 x M10	4 x M10	185	Max. 50
200kVA	5 x M10	4 x M10	5 x M10	4 x M10	240	Max. 50
250kVA	5 x M10	4 x M10	5 x M10	4 x M10	240	Max. 50
300kVA	5 x M10	4 x M10	5 x M10	4 x M10	240	Max. 50
400kVA	3x (5 x M12)	3x (4 x M12)	3x (5 x M12)	3x (4 x M12)	240	Max 84
500kVA	3x (5 x M12)	3x (4 x M12)	3x (5 x M12)	3x (4 x M12)	240	Max 84

Single/dual feed input

The UPS can be configured for either a 'single feed' or 'dual feed' input. In the case of a single feed input (standard) the bypass supply terminals are linked to the mains supply terminals and the mains supply cables therefore feed both inputs. Where a 'dual feed' configuration is used, the links between the bypass supply and mains supply terminals are removed and the bypass supply is connected to a dedicated power source.

Note: Internal rear access is required to reconfigure the single/dual feed configuration in a 400/500kVA model. If the cabinet is to be placed against a wall, any configuration change must be carried out before the cabinet is finally positioned.

Input/output supply protection

The UPS mains/bypass supply cables must be connected via an LV-Distribution board in which suitable fuses or circuit breakers are installed to provide both overload protection and a means of isolating the UPS from the mains supply when required. Similarly, the UPS output cables should be connected to the load equipment via a load distribution panel containing suitable load protection devices.

FUSE & CABLE SIZING

The diagrams on page 21 and page 22 identify the UPS input/output cabling requirements and provide information regarding the external fuse ratings and cable sizes.

Notes:

1. It is the customer's responsibility to provide all the external fuses, isolators and cables used to connect the UPS inputs and outputs to the power distribution boards.
2. **Fuse and Cable recommendations to IEC 60950-1:2001.**
3. The fuse and cable rating details in the tables are provided as a recommendation only.
4. The UPS must be installed to prescribed IEC or local regulations (e.g. BS7671:2008).

UPS Module power connections

**60kVA- 100kVA
 Power connections**

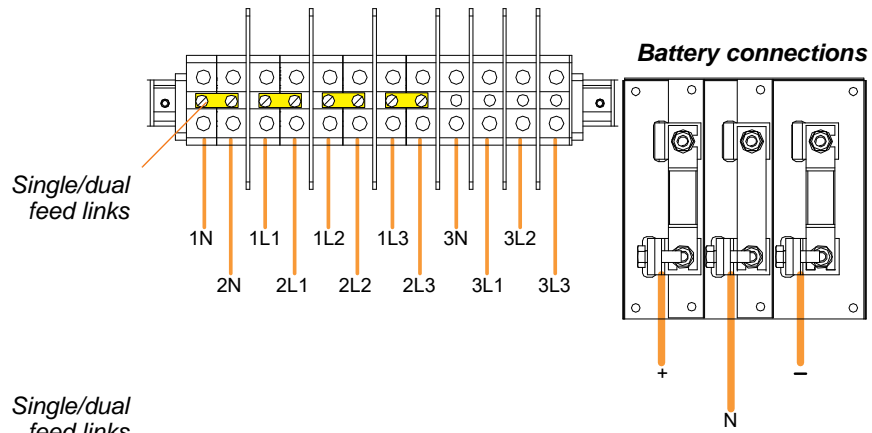

**120kVA- 200kVA
 Power connections**

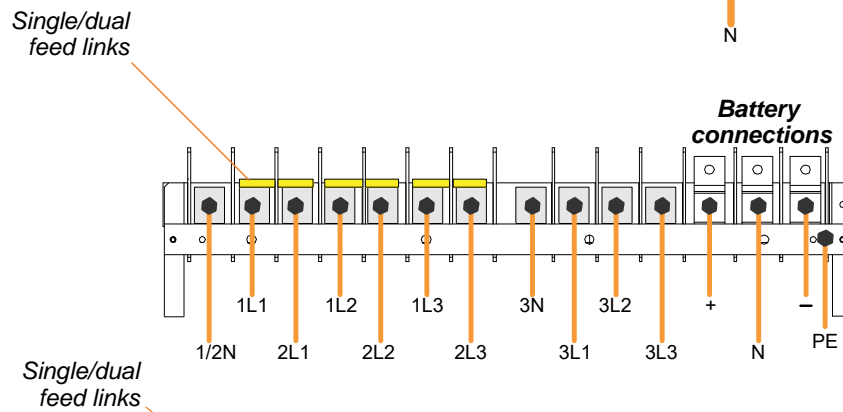

**250kVA- 300kVA
 Power connections**

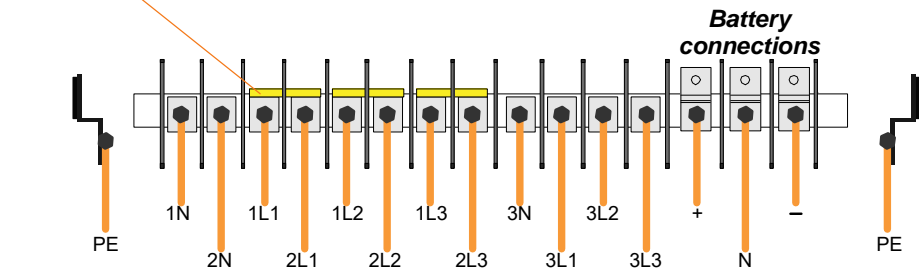

**400kVA - 500kVA
 Power connections**

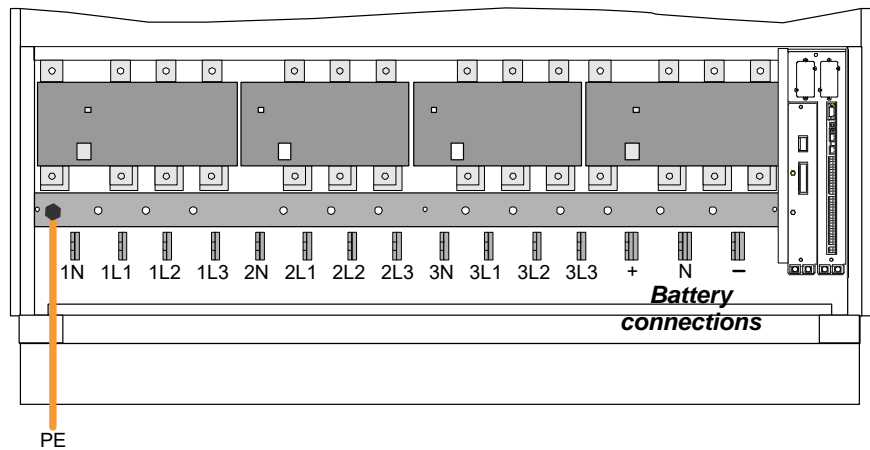

External fuse and cable rating for single-feed input

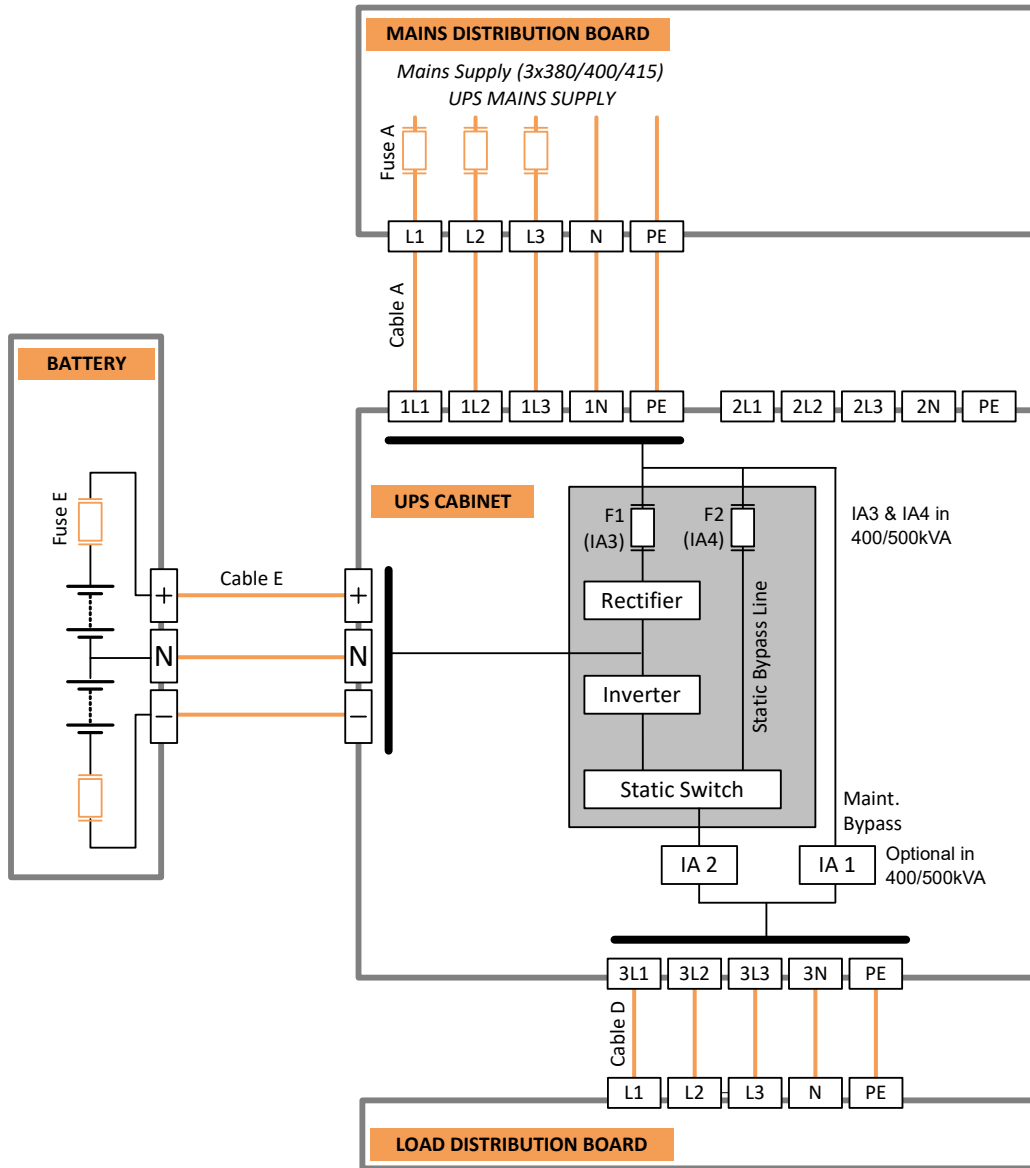

Power (kVA)	Fuse A (Agl/CB)	Cable A	Cable D
60	3x100	5x35	5x35
80	3x125	5x50	5x50
100	3x160	5x50	5x50
120	3x200	5x70	5x70
160	3x250	5x120 or 5x(2x50)	5x120 or 5x(2x50)
200	3x315	5x185 or 5x(2x70)	5x185 or 5x(2x70)
250	3x400	5x240 or 5x(2x95)	5x240 or 5x(2x95)
300	3x500	5x(2X120)	5x(2X120)
400	3x630	5x (3x95) or 5x (2x185)	5x (3x95) or 5x (2x185)
500	3x800	5x (3x150)	5x (3x150)

Note: Cable E and Fuse E are bespoke to the installation

External fuse and cable rating for dual-feed input

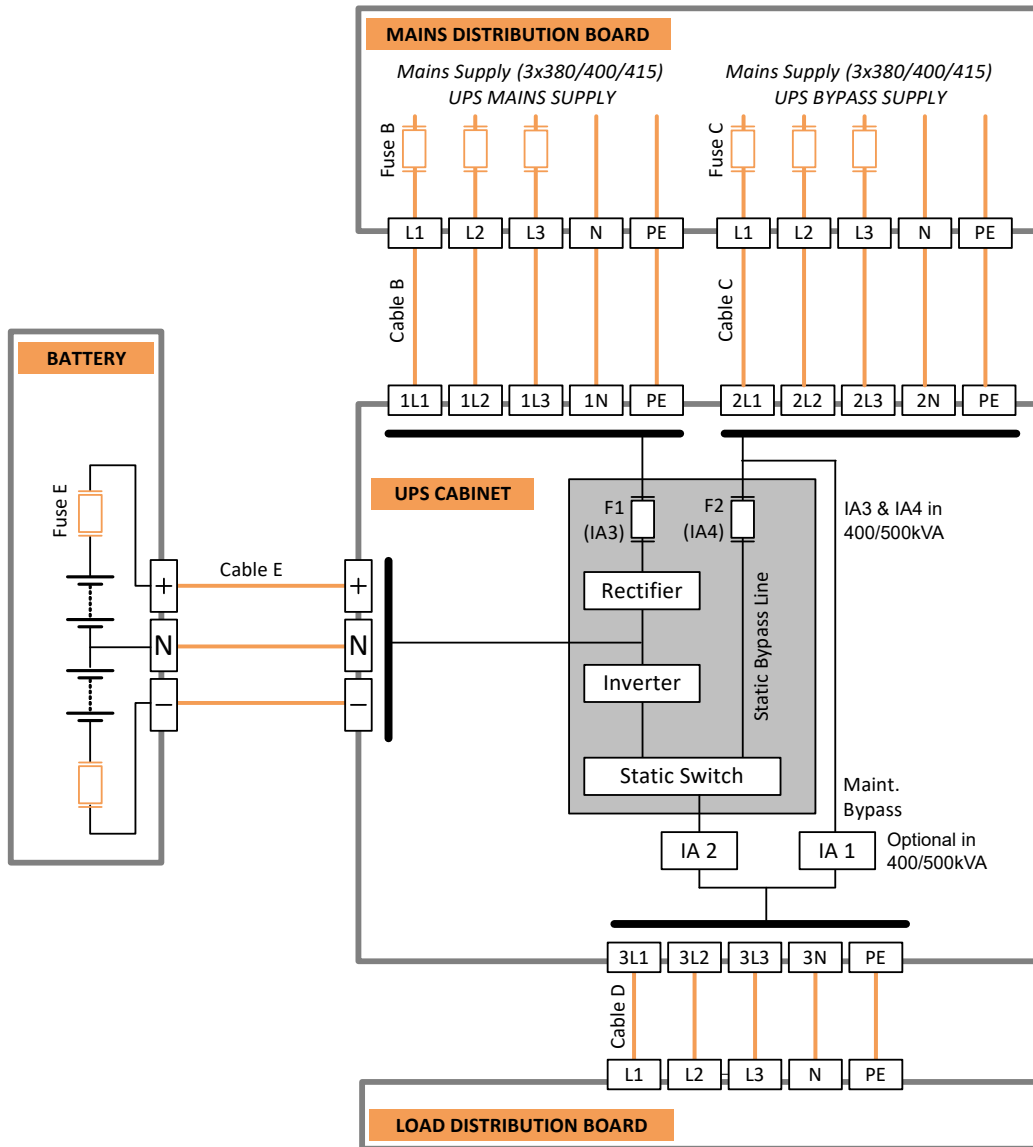

Power (kVA)	Fuse B (Ag/CB)	Cable B	Fuse C (Ag/CB)	Cable C	Cable D
60	3x100	5x35	3x100	5x35	5x35
80	3x125	5x50	3x125	5x50	5x50
100	3x160	5x50	3x160	5x50	5x50
120	3x200	5x70	3x200	5x70	5x70
160	3x250	5x120 or 5x(2x50)	3x250	5x120 or 5x(2x50)	5x120
200	3x315	5x185 or 5x(2x70)	3x315	5x185 or 5x(2x70)	5x185
250	3x400	5x240 or 5x(2x95)	3x400	5x240 or 5x(2x95)	5x240 or 5x(2x95)
300	3x500	5x(2x120)	3x500	5x(2x120)	5x(2x120)
400	3x630	5x(3x95) or 5x(2x185)	3x630	5x (3x95) or 5x(2x185)	5x(3x95) or 5x(2x185)
500	3x800	5x (3x150)	3x800	5x50	5x(3x150)

Note: Cable E and Fuse E are bespoke to the installation